









PROJETO	PAVIMENTAÇÃO EM PEDRA TOSCA NO MUNICÍPIO DE QUIXADÁ - DIVERSAS RUAS
CONTRATANTE	GOVERNO MUNICIPAL DE QUIXADÁ - CEARÁ
ENDEREÇO	RUA PRINCIPAL - SEDE - QUIXADÁ - CE
CONTEÚDO	DETALHES CONSTRUTIVOS - MEIO FIO E SARJETAS

 IMÓVEIS  AQUEDUS / LAGOAS  VIAS DE ACESSO	 CERCA  EIXO PROJETO  BUENRO CAPEADO  BUENRO TUBULAR	 PROJETO  TERRENO N
---	---	--

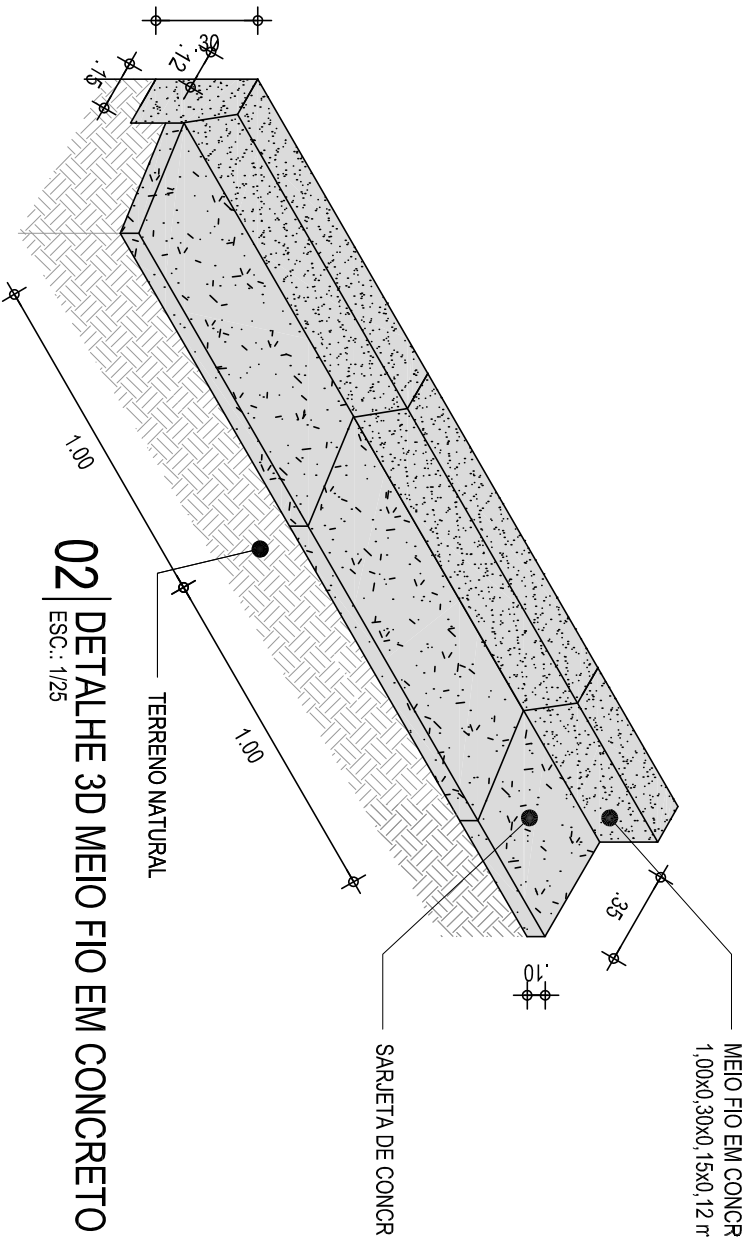

PROJETO GEOMÉTRICO